



LIGHTING FOREVER

# 6 PIN DIP PHOTOTRANSISTOR PHOTOCOUPLER

# TIL11X Series MCT2X Series

## Features

- TIL11X series: TIL111, TIL117
- MCT2X series: MCT2, MCT2E
- High isolation voltage between input and output  
Viso = 5000 Vrms
- Creepage distance >7.6mm
- Compact dual-in-line package
- Operating temperature up to +110°C
- Pb free and RoHS compliant.
- UL approved (No. E214129)
- VDE approved (No. 132249)
- SEMKO approval
- NEMKO approved
- DEMKO approved
- FIMKO approved
- CSA approved
- CQC approved

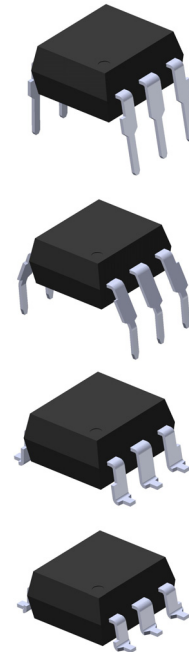

## Description

The TIL11X series and MCT2X series of devices each consist of an infrared emitting diode optically coupled to a phototransistor detector. They are packaged in a 6-pin DIP package and available in wide-lead spacing and SMD option.

## Applications

- Power supply regulators
- Digital logic inputs
- Microprocessor inputs
- Appliance system
- Industrial controls

## Schematic

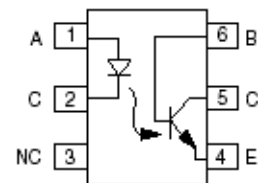

1. Anode
2. Cathode
3. No Connection
4. Emitter
5. Collector
6. Base



LIGHTING FOREVER

## 6 PIN DIP PHOTOTRANSISTOR PHOTOCOUPLER

## TIL11X Series MCT2X Series

### Absolute Maximum Ratings ( $T_A=25^{\circ}\text{C}$ )

Parameter		Symbol	Rating	Unit
Input	Forward current	$I_F$	60	mA
	Peak forward current ( $t = 10\mu\text{s}$ )	$I_{FM}$	1	A
	Reverse voltage	$V_R$	6	V
	Power dissipation	$P_D$	100	mW
	Derating factor (above $100^{\circ}\text{C}$ )		3.8	$\text{mW}/^{\circ}\text{C}$
Output	Collector power dissipation	$P_C$	150	mW
	Derating factor (above $100^{\circ}\text{C}$ )		9.0	$\text{mW}/^{\circ}\text{C}$
	Collector-Emitter voltage	$V_{CEO}$	80	V
	Collector-Base voltage	$V_{CBO}$	80	V
	Emitter-Collector voltage	$V_{ECO}$	7	V
Total power dissipation		$P_{tot}$	200	mW
Isolation voltage <sup>*2</sup>		$V_{iso}$	5000	V <sub>rms</sub>
Operating temperature		$T_{opr}$	-55~+110	$^{\circ}\text{C}$
Storage temperature		$T_{stg}$	-55~+125	$^{\circ}\text{C}$
Soldering temperature <sup>*3</sup>		$T_{sol}$	260	$^{\circ}\text{C}$

### Notes

\*1 AC for 1 minute, R.H.= 40 ~ 60% R.H. In this test, pins 1, 2 & 3 are shorted together, and pins 4, 5 & 6 are shorted together.

\*2 For 10 seconds.



LIGHTING FOREVER

# 6 PIN DIP PHOTOTRANSISTOR PHOTOCOUPLER

# TIL11X Series MCT2X Series

## Electrical Characteristics (T<sub>A</sub>=25°C unless specified otherwise)

### Input

Parameter	Symbol	Min.	Typ.*	Max.	Unit	Condition
Forward voltage	TIL111	-	1.22	1.4	V	I <sub>F</sub> = 16mA
	TIL117	-	-	1.4		T <sub>A</sub> =0-70°C, I <sub>F</sub> = 16mA
		-	1.32	-		T <sub>A</sub> = -55°C, I <sub>F</sub> = 16mA
		-	1.1	-		T <sub>A</sub> =110°C, I <sub>F</sub> = 16mA
	MCT2 MCT2E	-	1.23	1.5		I <sub>F</sub> = 20mA
Reverse current	I <sub>R</sub>	-	-	10	μA	V <sub>R</sub> = 6V

### Output

Parameter	Symbol	Min.	Typ.*	Max.	Unit	Condition
Collector-Base dark current	I <sub>CB0</sub>	-	-	20	nA	V <sub>CB</sub> = 10V
Collector-Emitter dark current	All	-	1	50	nA	V <sub>CE</sub> = 10V, I <sub>F</sub> = 0mA
	TIL117	-	0.2	50	nA	V <sub>CE</sub> = 30V, I <sub>F</sub> = 0mA, T <sub>A</sub> =70°C
Collector-Emitter breakdown voltage	BV <sub>CEO</sub>	80	-	-	V	I <sub>C</sub> = 1mA
Collector-Base breakdown voltage	BV <sub>CBO</sub>	80	-	-	V	I <sub>C</sub> = 0.01mA
Emitter-Collector breakdown voltage	BV <sub>ECO</sub>	7	-	-	V	I <sub>E</sub> = 0.1mA
Emitter-Base breakdown voltage	BV <sub>EBO</sub>	7	-	-	V	I <sub>E</sub> = 0.1mA

### Transfer Characteristics

Parameter	Symbol	Min.	Typ.*	Max.	Unit	Condition	
Collector current (Phototransistor operation)	TIL111	I <sub>C(ON)</sub>	2	-	-	mA	I <sub>F</sub> = 16mA, V <sub>CE</sub> = 0.4V
Collector current (Photodiode operation)			7	-	-	μA	I <sub>F</sub> = 16mA, V <sub>CB</sub> = 0.4V
Current Transfer Ratio	TIL117	CTR	50	-	-	%	I <sub>F</sub> = 10mA, V <sub>CE</sub> = 10V
	MCT2 MCT2E		20	-	-		I <sub>F</sub> = 10mA, V <sub>CE</sub> = 10V



LIGHTING FOREVER

# 6 PIN DIP PHOTOTRANSISTOR PHOTOCOUPLER

# TIL11X Series MCT2X Series

## Transfer Characteristics

Parameter		Symbol	Min.	Typ.*	Max.	Unit	Condition
Collector-Emitter saturation voltage	All	$V_{CE(sat)}$	-	-	0.4	V	$I_F = 16mA, I_C = 2mA$
	TIL117		-	-	0.4		$I_F = 10mA, I_C = 0.5mA$
Isolation resistance		$R_{IO}$	$10^{11}$	-	-	$\Omega$	$V_{IO} = 500Vdc$
Input-output capacitance		$C_{IO}$	-	-	2	pF	$V_{IO} = 0, f = 1MHz$
Turn-on time	TIL117	$T_{on}$	-	10	12	$\mu s$	$V_{CC} = 10V, I_C = 2mA, R_L = 100\Omega$
Turn-off time	TIL117	$T_{off}$	-	9	12		
Rise time	TIL117 TIL111	$t_r$	-	6	10		
Fall time	TIL117 TIL111	$t_f$	-	8	10		
Turn-on time	MCT2 MCT2E	$T_{on}$	-	3	10	$\mu s$	$V_{CC} = 10V, I_F = 10mA, R_L = 100\Omega$
Turn-off time	MCT2 MCT2E	$T_{off}$	-	3	10		
Rise time	MCT2 MCT2E	$t_r$	-	3	10		
Fall time	MCT2 MCT2E	$t_f$	-	3	10		

\* Typical values at  $T_a = 25^\circ C$

# 6 PIN DIP PHOTOTRANSISTOR PHOTOCOUPLER

# TIL11X Series MCT2X Series

## Typical Performance Curves

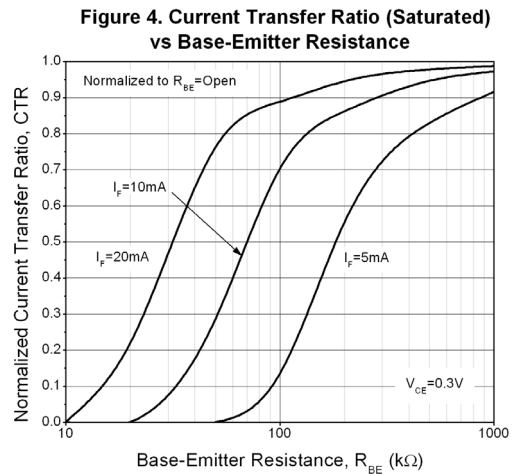
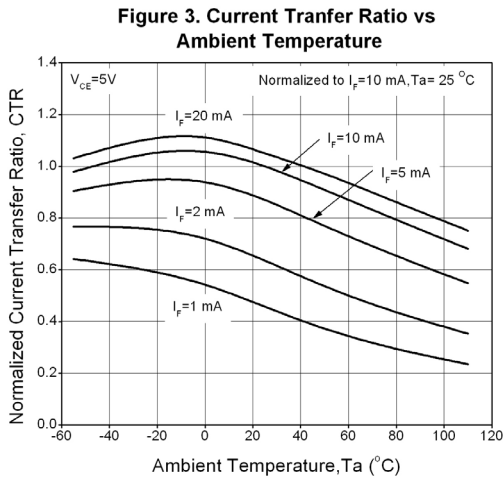
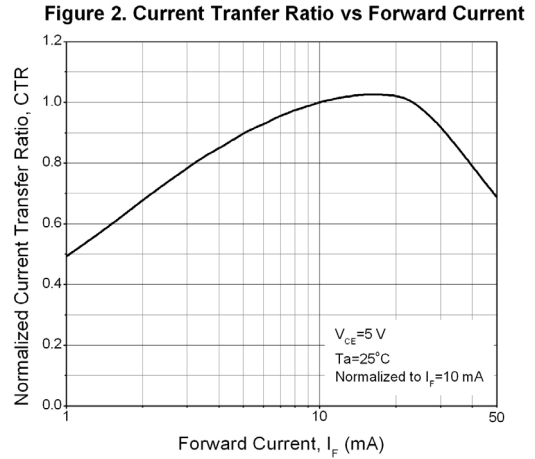

# 6 PIN DIP PHOTOTRANSISTOR PHOTOCOUPLER

# TIL11X Series MCT2X Series

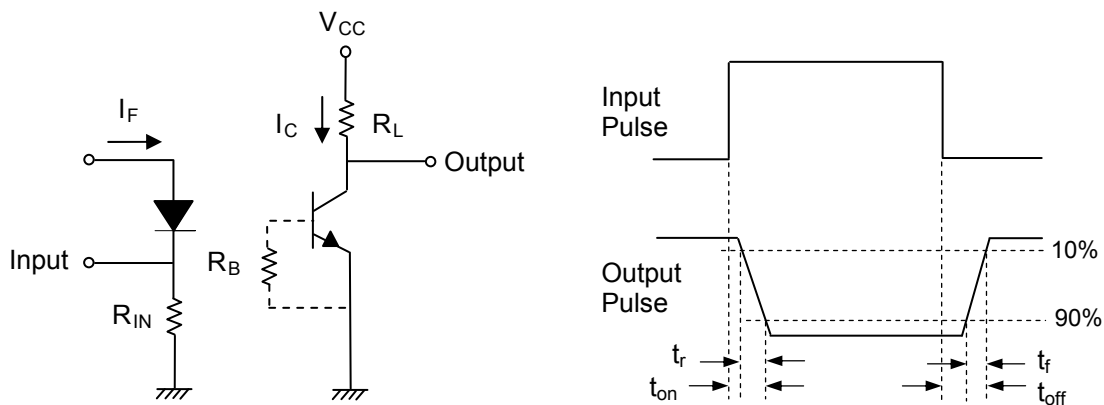
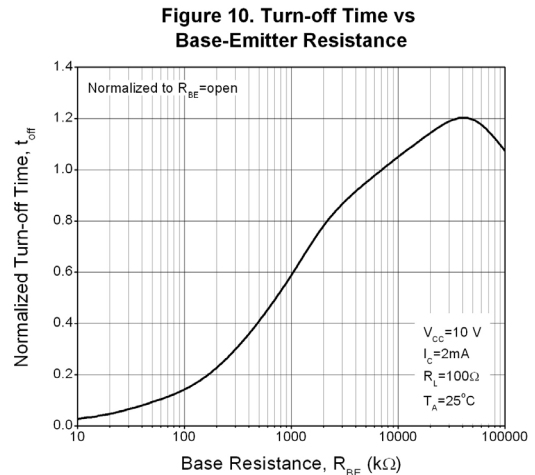
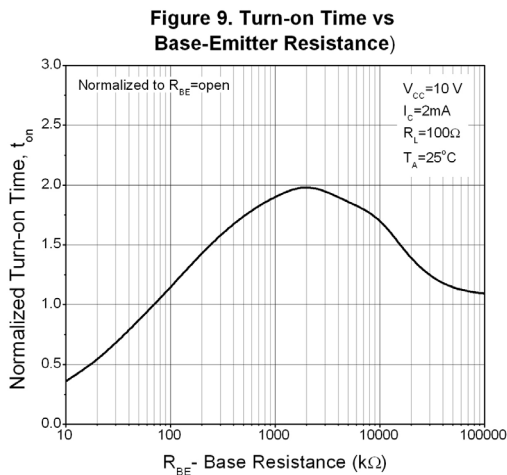
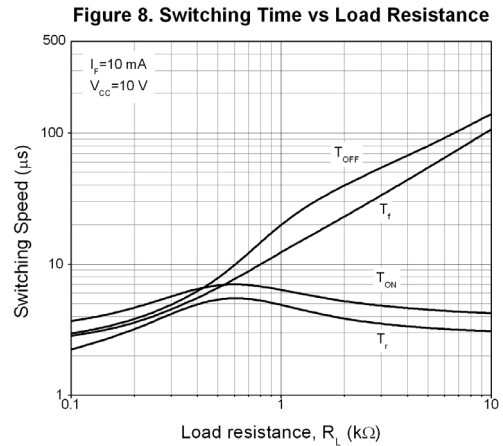
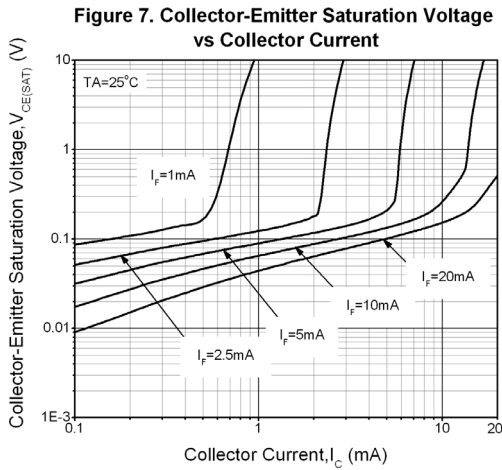

**Figure 11. Switching Time Test Circuit & Waveforms**



LIGHTING FOREVER

# 6 PIN DIP PHOTOTRANSISTOR PHOTOCOUPLER

**TIL11X Series**  
**MCT2X Series**

## Order Information

### Part Number

**TIL11XY(Z)-V**

or

**MCT2XY(Z)-V**

### Note

- X = Part no. for MCT2X series (E or none)  
= Part no. for TIL11X series (1 or 7)
- Y = Lead form option (S, S1, M or none)
- Z = Tape and reel option (TA, TB or none).
- V = VDE safety (optional)

Option	Description	Packing quantity
None	Standard DIP-6	65 units per tube
M	Wide lead bend (0.4 inch spacing)	65 units per tube
S (TA)	Surface mount lead form + TA tape & reel option	1000 units per reel
S (TB)	Surface mount lead form + TB tape & reel option	1000 units per reel
S1 (TA)	Surface mount lead form (low profile) + TA tape & reel option	1000 units per reel
S1 (TB)	Surface mount lead form (low profile) + TB tape & reel option	1000 units per reel



LIGHTING FOREVER

# 6 PIN DIP PHOTOTRANSISTOR PHOTOCOUPLER

# TIL11X Series MCT2X Series

## Package Drawings

(Dimensions in mm)

### Standard DIP Type

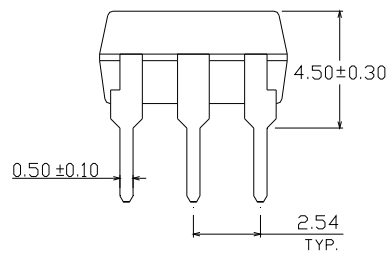
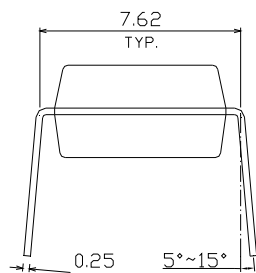
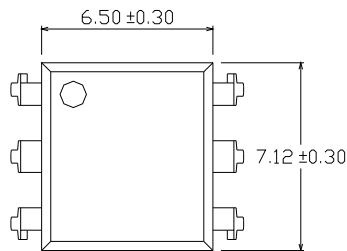

### Option M Type

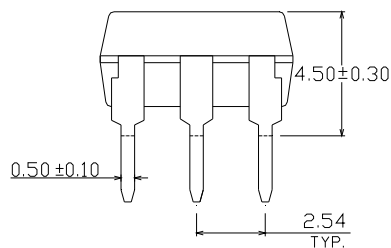
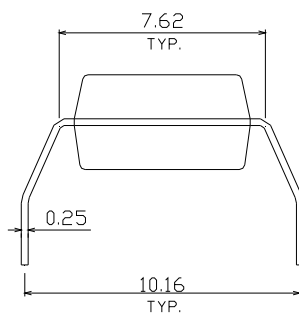
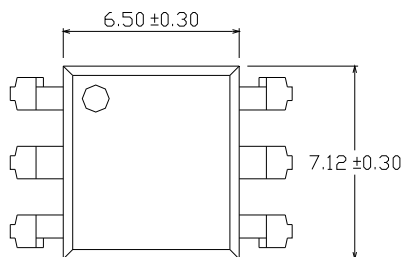





LIGHTING FOREVER

# 6 PIN DIP PHOTOTRANSISTOR PHOTOCOUPLER

## TIL11X Series MCT2X Series

### Option S Type

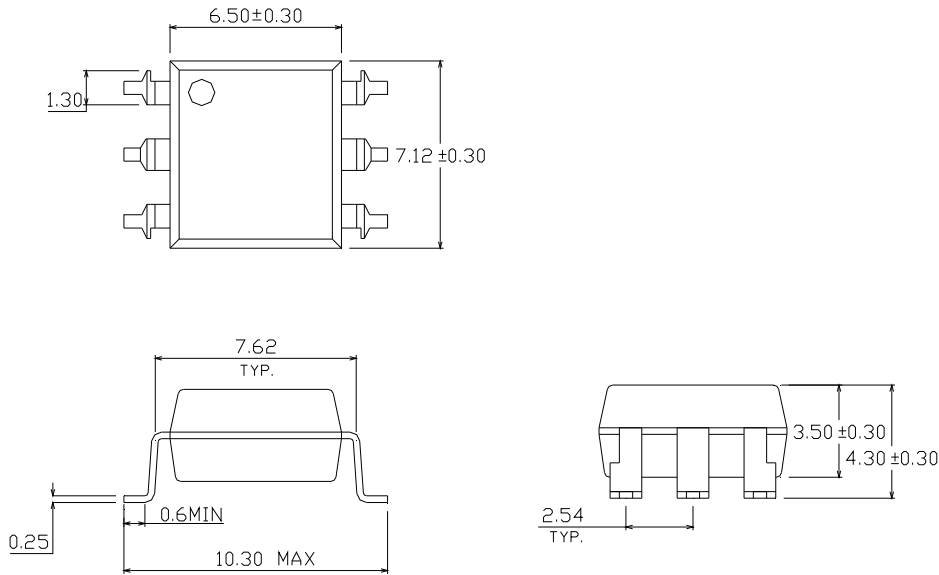

### Option S1 Type

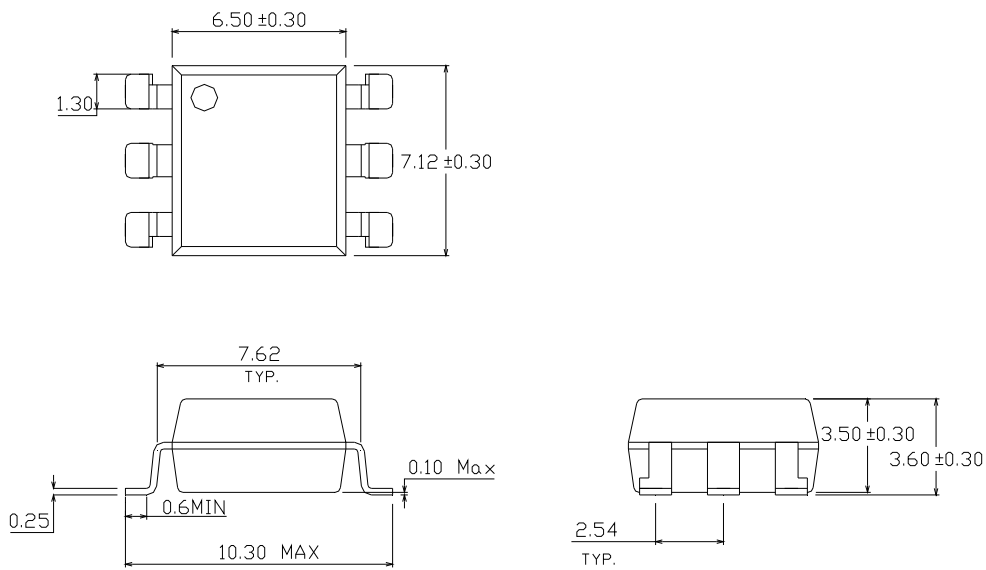



LIGHTING FOREVER

# 6 PIN DIP PHOTOTRANSISTOR PHOTOCOUPLER

## TIL11X Series MCT2X Series

### Recommended pad layout for surface mount leadform

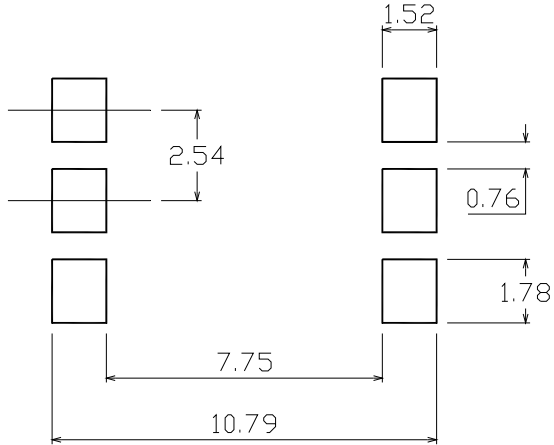

### Device Marking

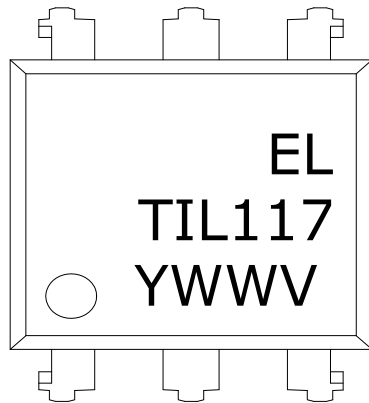

### Notes

- EL denotes Everlight
- TIL117 denotes Device Number
- Y denotes 1 digit Year code
- WW denotes 2 digit Week code
- V denotes VDE optional

# 6 PIN DIP PHOTOTRANSISTOR PHOTOCOUPLER

# TIL11X Series MCT2X Series

## Tape & Reel Packing Specifications

**Option TA**

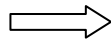
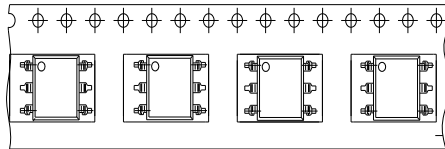

Direction of feed from reel

**Option TB**

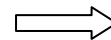
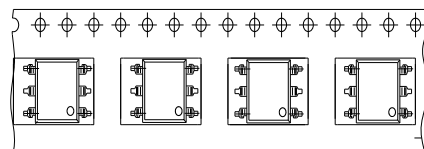

Direction of feed from reel

## Tape dimensions

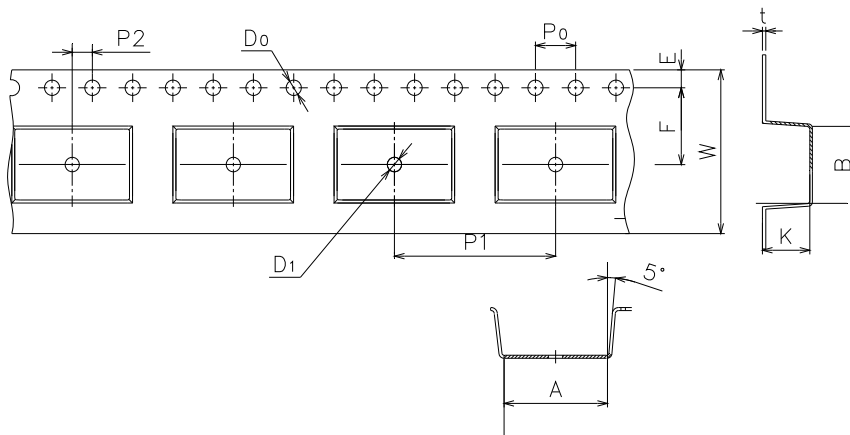

Dimension No.	A	B	Do	D1	E	F
Dimension (mm)	10.4±0.1	7.52±0.1	1.5±0.1	1.5+0.1/-0	1.75±0.1	7.5±0.1

Dimension No.	Po	P1	P2	t	W	K
Dimension (mm)	4.0±0.15	16.0±0.1	2.0±0.1	0.35±0.03	16.0±0.2	4.5±0.1



LIGHTING FOREVER

# 6 PIN DIP PHOTOTRANSISTOR PHOTOCOUPLER

# TIL11X Series MCT2X Series

## Solder Reflow Temperature Profile

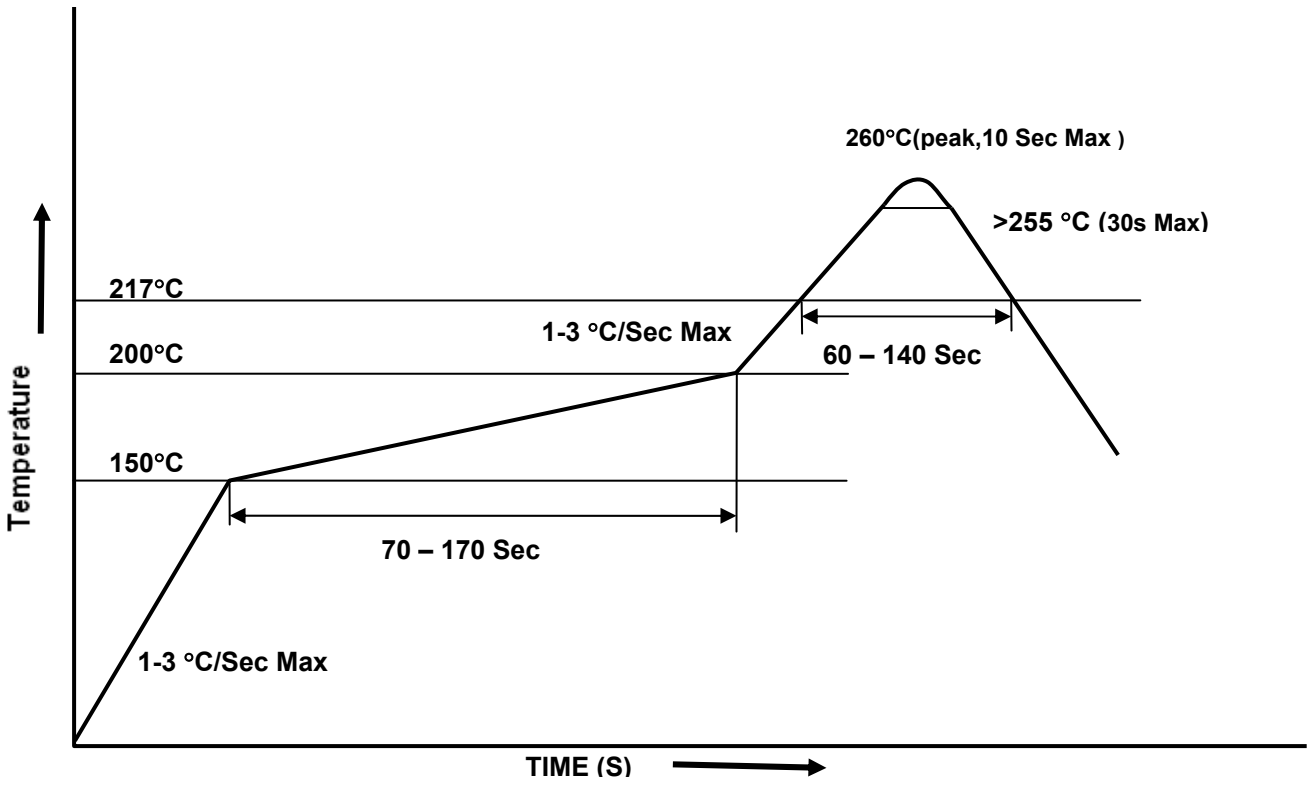



LIGHTING FOREVER

## 6 PIN DIP PHOTOTRANSISTOR PHOTOCOUPLER

TIL11X Series  
MCT2X Series

---

### DISCLAIMER

1. Above specification may be changed without notice. EVERLIGHT will reserve authority on material change for above specification.
2. When using this product, please observe the absolute maximum ratings and the instructions for use outlined in these specification sheets. EVERLIGHT assumes no responsibility for any damage resulting from use of the product which does not comply with the absolute maximum ratings and the instructions included in these specification sheets.
3. These specification sheets include materials protected under copyright of EVERLIGHT. Reproduction in any form is prohibited without the specific consent of EVERLIGHT.