

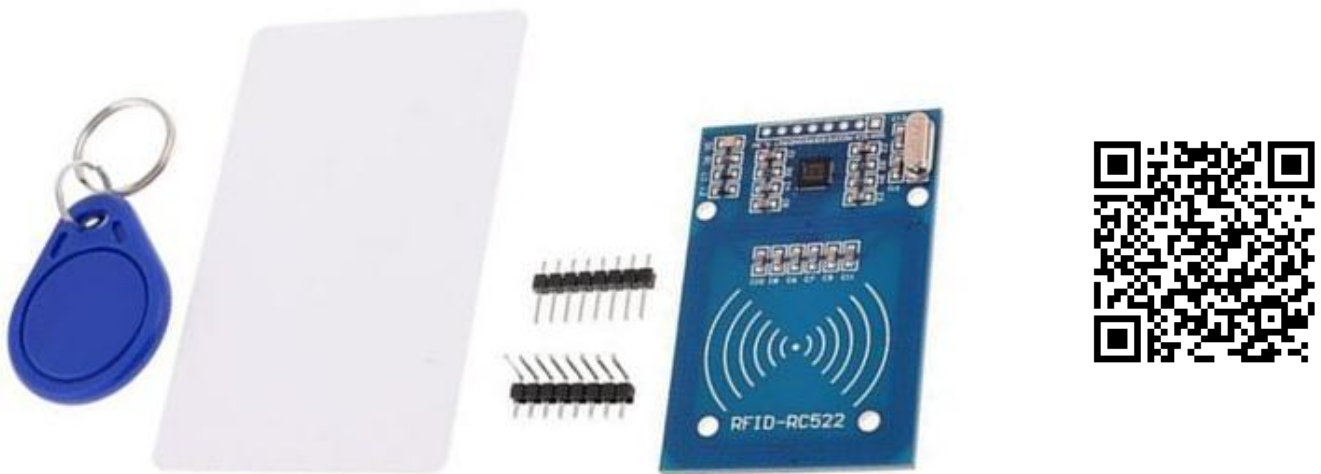

## RC522 RFID Development Kit

This RC522 RFID Development kit is based on NXP's a highly integrated reader/writer IC MFRC522 for contactless communication at 13.56 MHz. The MFRC522 reader supports ISO/IEC 14443 A/MIFARE and NTAG. The MFRC522's internal transmitter is able to drive a reader/ writer antenna designed to communicate with ISO/IEC 14443A cards and transponders without additional active circuitry. The receiver module provides a robust and efficient implementation for demodulating and decoding signals from ISO/IEC 14443A compatible cards and transponders.



SKU: [MDU1040](#)

### Brief Data:

- Operating Voltage: 2.5V~3.3V.
- Operating/Standby current: 13~26mA/10~13mA.
- Operating Frequency: 13.56MHz.
- Supports ISO/IEC 14443A higher transfer speed communication up to 848 KBd.
- SPI bus speed up to 10Mbit/s.
- I2C-bus interface up to 400 kBd in Fast mode, up to 3400 kBd in High-speed mode.
- RS232 Serial UART up to 1228.8 kBd, with voltage levels dependant on pin voltage supply.
- Compatible with MIFARE and ISO 14443A cards.
- Typical operating distance in Read/Write mode up to 50 mm depending on the antenna size and tuning.

## Interface Pins Function:

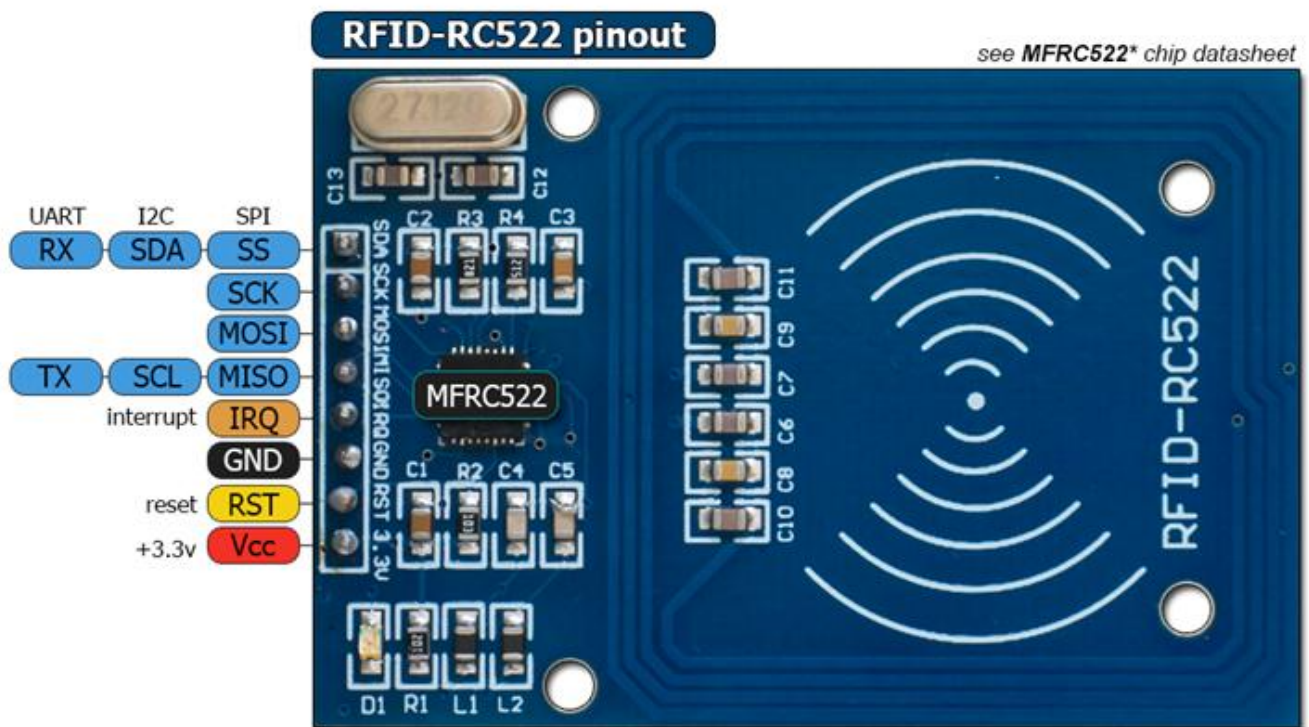

## Mechanical Dimension:

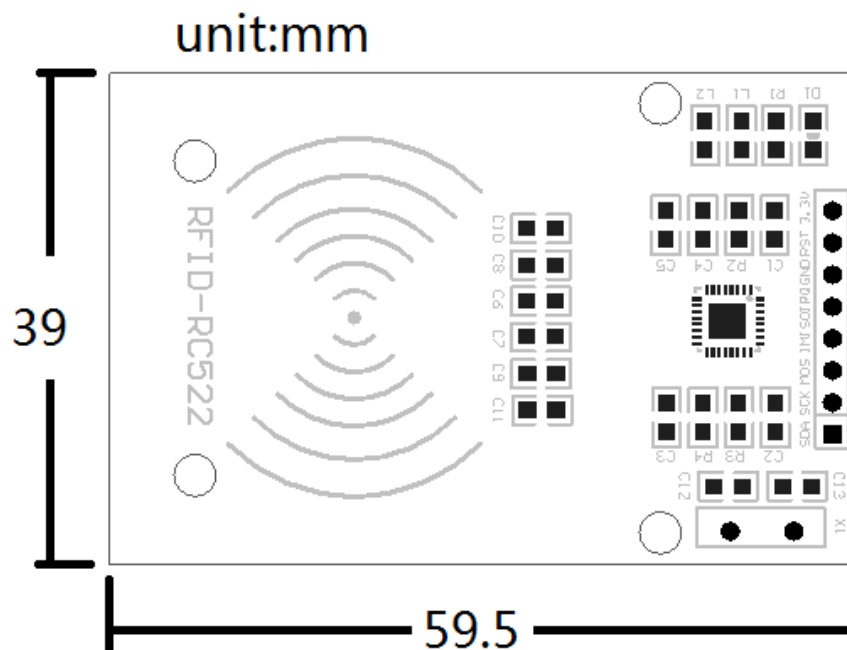

*P.S: This module does not support RFID cards which operate at 125KHz frequency range. It supports only the cards which operate at 13.56MHz frequency range.*

## Application Example with Arduino:

### Library download:

Here's the library you need for this project:

1. Download the [RFID library here](#) created by miguelbalboa
2. Unzip the RFID library
3. Install the RFID library in your Arduino IDE
4. Restart your Arduino IDE

### Arduino Circuit Connection:

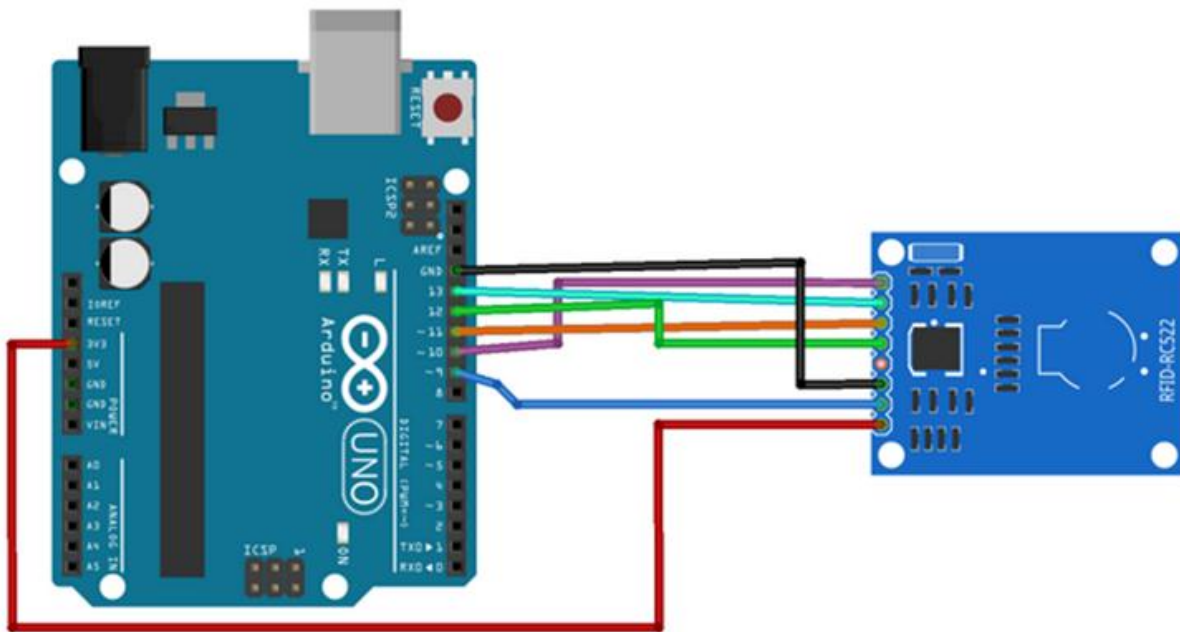

RC522 Pin	Wiring to Arduino Un
SDA	Digital 10
SCK	Digital 13
MOSI	Digital 11
MISO	Digital 12
IRQ	unconnected
GND	GND
RST	Digital 9
3.3V Supply	3.3V

Pin Wiring

### Reading Data from a RFID Tag:

After having the circuit ready, go to File > Examples > MFRC522 > DumpInfo and upload the code. This code will be available in your Arduino IDE (after installing the RFID library).

Then, open the serial monitor with 9600 baud. You should see something like the figure below:

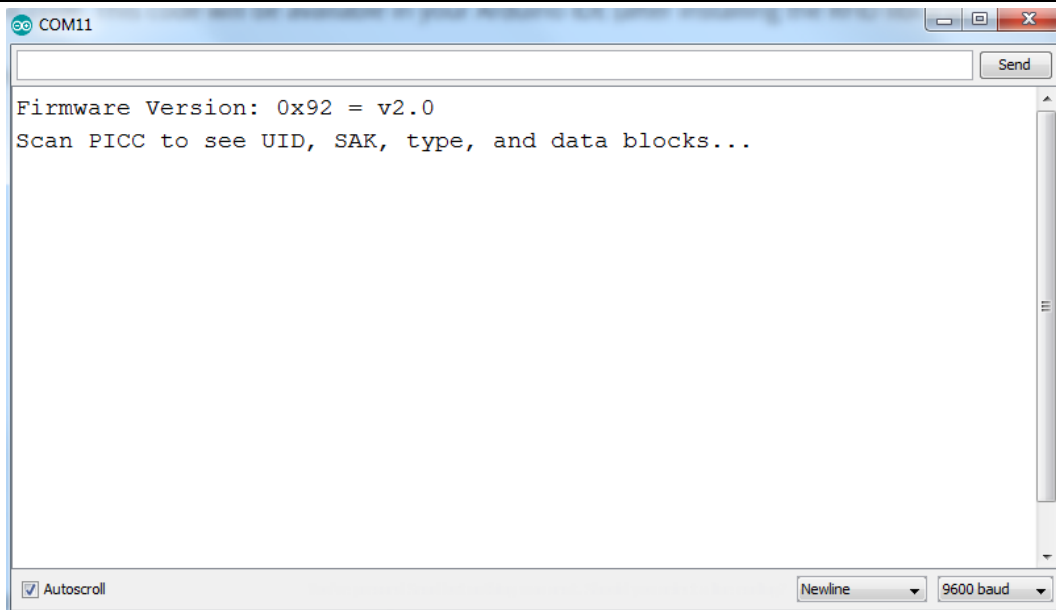

Put the RFID card or the keychain to the reader. Let the reader and the tag closer until all the information is displayed.

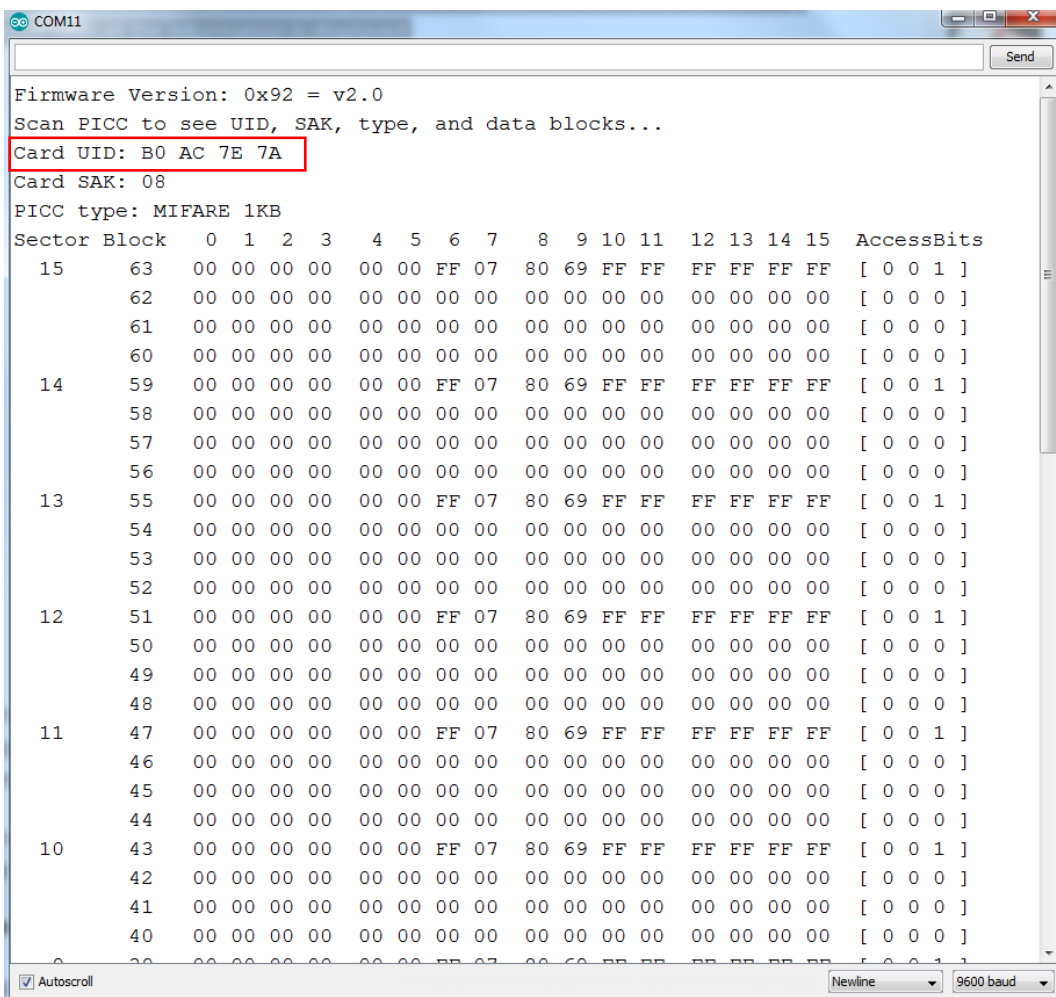

This is the information that you can read from the card, including the card UID that is highlighted in red. The information is stored in the memory that is divided into segments and blocks as you can see in the previous picture.

You have 1024 bytes of data storage divided into 16 sectors and each sector is protected by two different keys, A and B.

Write down your UID card because you'll need it later. In this case, **Card UID: B0 AC 7E 7A.**

Upload the following code to the Arduino Board:

```
=====
/*
 *
 * All the resources for this project:
 * Modified by Handson Technology
 * www.handsontec.com
 * Created by Handsontec Tech team
 *
 */

#include <SPI.h>
#include <MFRC522.h>

#define SS_PIN 10
#define RST_PIN 9

MFRC522 mfrc522(SS_PIN, RST_PIN); // Create MFRC522 instance.

void setup()
{
  Serial.begin(9600); // Initiate a serial communication
  SPI.begin(); // Initiate SPI bus
  mfrc522.PCD_Init(); // Initiate MFRC522
  Serial.println("Put close your card to the reader...");
  Serial.println();
}

void loop()
{
  // Look for new cards
  if (!mfrc522.PICC_IsNewCardPresent())
  {
    return;
  }
  // Select one of the cards
  if (!mfrc522.PICC_ReadCardSerial())
  {
    return;
  }

  // Show UID on serial monitor
  Serial.print("UID tag :");
  String content = "";
  byte letter;
  for (byte i = 0; i < mfrc522.uid.size; i++)
  {
    Serial.print(mfrc522.uid.uidByte[i] < 0x10 ? " 0" : " ");
    Serial.print(mfrc522.uid.uidByte[i], HEX);
    content.concat(String(mfrc522.uid.uidByte[i] < 0x10 ? " 0" : " "));
    content.concat(String(mfrc522.uid.uidByte[i], HEX));
  }

  Serial.println();
  Serial.print("Message : ");
  content.toUpperCase();
}
```

```

if (content.substring(1) == "B0 AC 7E 7A") //change here the UID of the card/cards that you want to give access
{
  Serial.println("Authorized access");
  Serial.println();
  delay(3000);
}

else {
  Serial.println(" Access denied");
  delay(3000);
}
}

```

=====

In the piece of code above you need to change the if (content.substring(1) == “REPLACE WITH YOUR UID”) and type the UID card you’ve written previously.

### **Demonstration:**

Now, upload the code to your Arduino and open the serial monitor. You will see the screen as below:

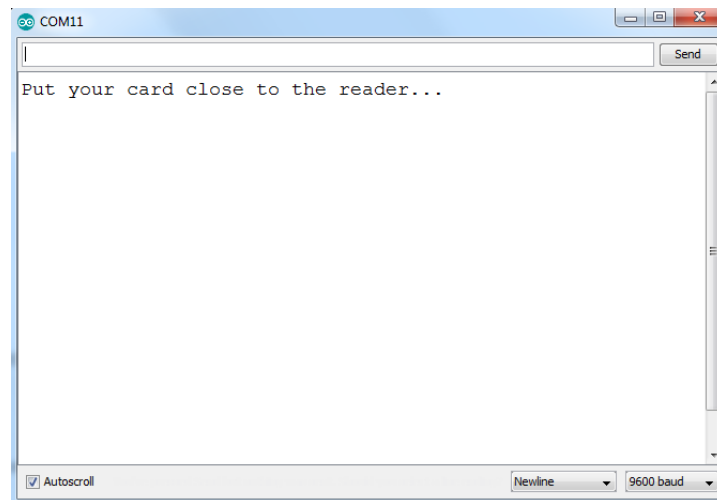

Put the card you’ve chosen to give access (in this case with UID: B0 AC 7E 7A) near to the reader module and you’ll see:

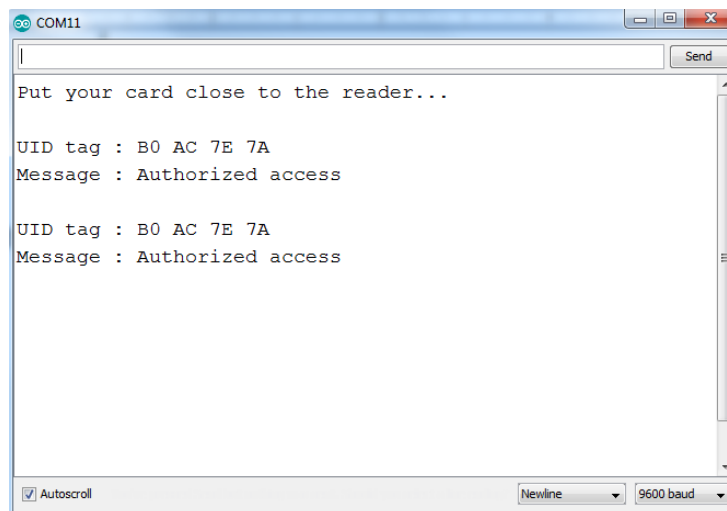

Now if you put close another tag with another UID, the denial message will show up:

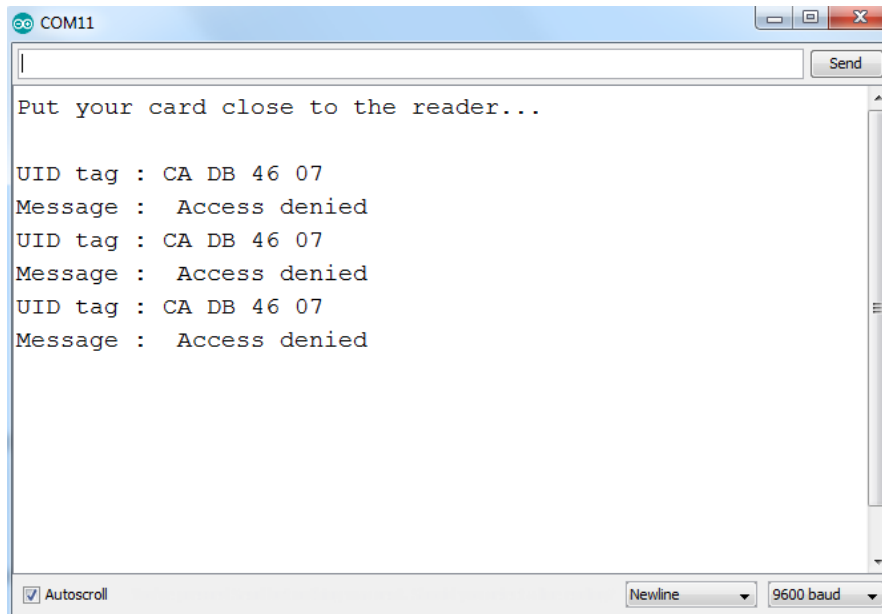

```
COM11
Put your card close to the reader...

UID tag : CA DB 46 07
Message : Access denied
UID tag : CA DB 46 07
Message : Access denied
UID tag : CA DB 46 07
Message : Access denied
```

Autoscroll Newline 9600 baud

This completed our initial testing & setup for RC522 RFID reader module, hope you found this tutorial useful.

### **This RFID Development Package include:**

- 1x RFID RC522 Reader Module
- 1x Credit card size RFID Card (M1 S50 IC Card)
- 1x RFID Keyring (M1 S50 Key tag)
- 1x 8-pin strait header connector
- 1x 8-pin right angle header connector

### **Web Resource:**

- [MDU1040 RC522](#)
- [Course Using the MF522 RFID Reader with the Arduino.](#)
- [MF1 S50 ISO/IEC14443A Contactless RFID Card](#)
- [MF1 S50 ISO/IEC14443A Contactless RFID Key Chain](#)



# Handsontec.com

*We have the parts for your ideas*

---

HandsOn Technology provides a multimedia and interactive platform for everyone interested in electronics. From beginner to diehard, from student to lecturer. Information, education, inspiration and entertainment. Analog and digital, practical and theoretical; software and hardware.



open source  
hardware

HandsOn Technology support Open Source Hardware (OSHW) Development Platform.

*Learn : Design : Share*

*[www.handsontec.com](http://www.handsontec.com)*





**The Face behind our product quality...**

**In a world of constant change and continuous technological development, a new or replacement product is never far away – and they all need to be tested.**

**Many vendors simply import and sell without checks and this cannot be the ultimate interests of anyone, particularly the customer. Every part sell on Handsotec is fully tested. So when buying from Handsontec products range, you can be confident you're getting outstanding quality and value.**

**We keep adding the new parts so that you can get rolling on your next project.**



[www.handsontec.com](http://www.handsontec.com)

[Breakout Boards & Modules](#)



[Connectors](#)



[www.handsontec.com](http://www.handsontec.com)

[Electro-Mechanical Parts](#)



[www.handsontec.com](http://www.handsontec.com)

[Engineering Material](#)



[www.handsontec.com](http://www.handsontec.com)

[Mechanical Hardware](#)



[Electronics Components](#)

P



[www.handsontec.com](http://www.handsontec.com)

[Power Supply](#)



[Arduino Board & Shield](#)

Tools & Accessory



[www.handsontec.com](http://www.handsontec.com)

[Tools & Accessory](#)