

---

# 2SC2512

Silicon NPN Triple Diffused

# HITACHI

---

## Application

- VHF Amplifier
- VHF TV Tuner, Mixer

## Outline

TO-92 (2)

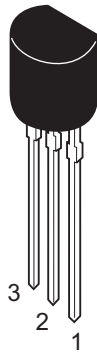

1. Base
2. Emitter
3. Collector

## 2SC2512

### Absolute Maximum Ratings (Ta = 25°C)

Item	Symbol	Ratings	Unit
Collector to base voltage	$V_{CBO}$	30	V
Collector to emitter voltage	$V_{CEO}$	20	V
Emitter to base voltage	$V_{EBO}$	3	V
Collector current	$I_C$	50	mA
Collector power dissipation	$P_C$	300	mW
Junction temperature	$T_j$	150	°C
Storage temperature	$T_{stg}$	-55 to +150	°C

### Electrical Characteristics (Ta = 25°C)

Item	Symbol	Min	Typ	Max	Unit	Test conditions
Collector to base breakdown voltage	$V_{(BR)CBO}$	30	—	—	V	$I_C = 10 \mu A, I_E = 0$
Collector to emitter breakdown voltage	$V_{(BR)CEO}$	20	—	—	V	$I_C = 1 \text{ mA}, R_{BE} = \infty$
Emitter to base breakdown voltage	$V_{(BR)EBO}$	3	—	—	V	$I_E = 10 \mu A, I_C = 0$
Collector cutoff current	$I_{CBO}$	—	—	0.5	$\mu A$	$V_{CB} = 10 \text{ V}, I_E = 0$
Collector to emitter saturation voltage	$V_{CE(sat)}$	—	—	1	V	$I_C = 20 \text{ mA}, I_B = 4 \text{ mA}$
DC current transfer ratio	$h_{FE}$	30	—	—		$V_{CE} = 10 \text{ V}, I_C = 10 \text{ mA}$
Reverse transfer capacitance	$C_{re}$	—	0.35	0.45	pF	$V_{CB} = 10 \text{ V}$ , Emitter common, $f = 1 \text{ MHz}$
Gain bandwidth product	$f_T$	600	900	—	MHz	$V_{CE} = 10 \text{ V}, I_C = 10 \text{ mA}$
Base time constant	$r_{bb'} \cdot C_C$	—	—	20	ps	$V_{CB} = 10 \text{ V}, I_C = 5 \text{ mA}$ , $f = 31.8 \text{ MHz}$
Conversion gain	CG	16	20	—	dB	$V_{CC} = 12 \text{ V}, I_C = 2 \text{ mA}$ , $f_{in} = 200 \text{ MHz}$ , $f_{OSC} = 260 \text{ MHz}$ , $f_{out} = 60 \text{ MHz}$
Noise figure	NF	—	3.8	5.5	dB	$V_{CC} = 12 \text{ V}, I_C = 2 \text{ mA}$ , $f_{OSC} = 260 \text{ MHz}, R_g = 50 \Omega$ , $f_{in} = 200 \text{ MHz}$

HITACHI

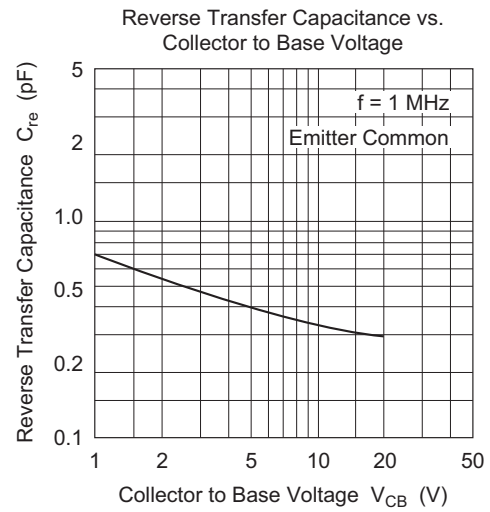
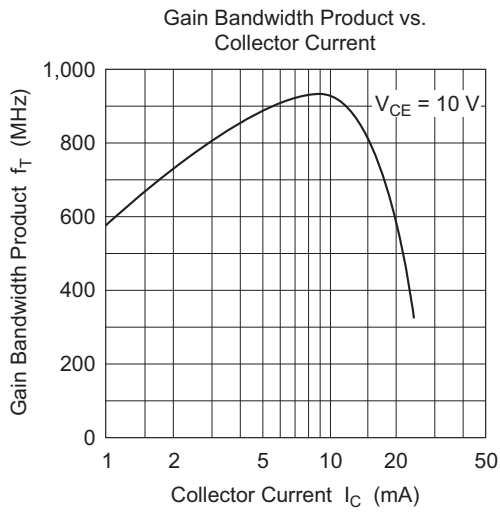
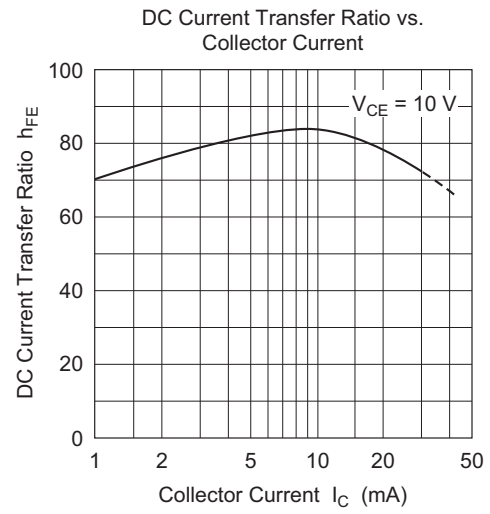
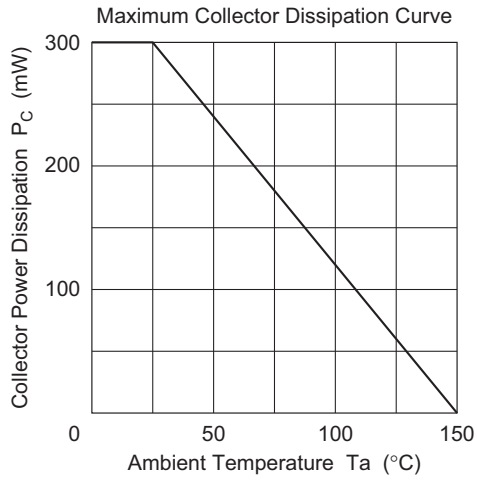

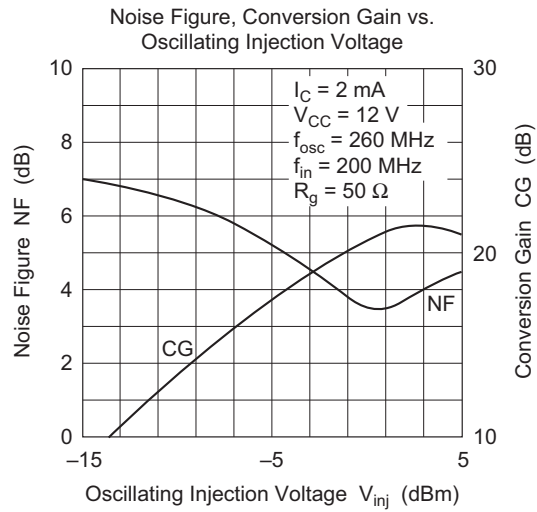
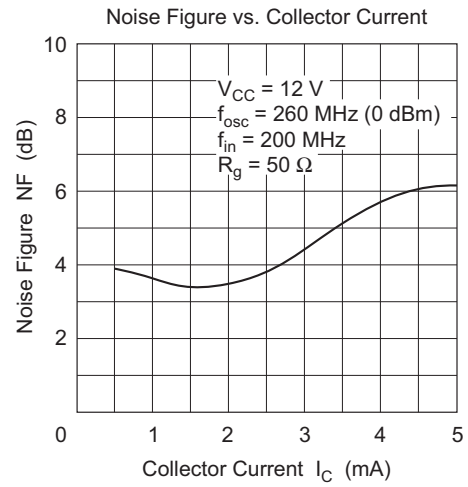
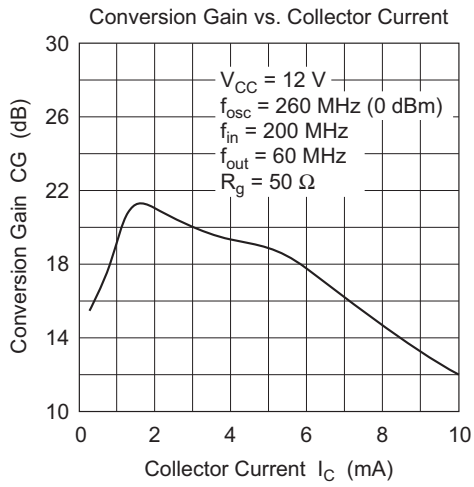

Conversion Gain, Noise Figure Test Circuit

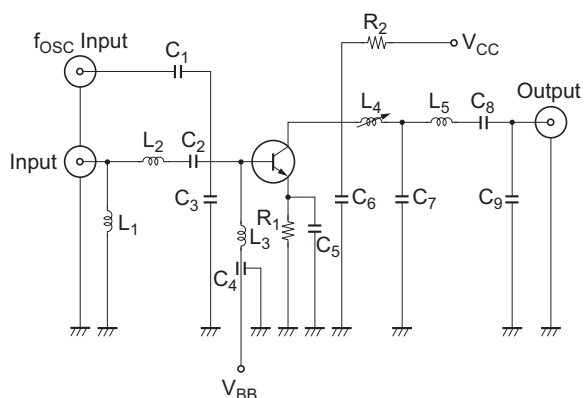

- $R_1$  : 330  $\Omega$  (1/4 W)  
 $R_2$  : 560  $\Omega$  (1/4 W)  
 $L_1$  :  $\phi$ 0.8 mm Copper wire with Enamel 8 Turns  
inside dia  $\phi$ 3 mm  
 $L_2$  :  $\phi$ 0.8 mm Copper wire with Enamel 5 Turns  
inside dia  $\phi$ 3 mm  
 $L_3$  :  $\phi$ 0.5 mm Copper wire with Enamel 3.5 Turns  
inside dia  $\phi$ 3 mm  
 $L_4$  : Outside dia  $\phi$ 5 mm used Ferrite Core,  $\phi$ 0.2 mm  
Copper wire with Enamel 6.5 Turns  
 $L_5$  :  $\phi$ 0.2 mm Copper wire with Enamel 13 Turns  
inside dia  $\phi$ 5 mm

## Parts Specification

- $C_1$  : 1.5 pF  
 $C_2$  : 57 pF  
 $C_3$  : 17 pF  
 $C_4$  : 1000 pF  
 $C_5$  : 2200 pF  
 $C_6$  : 22 pF  
 $C_7$  : 80 pF  
 $C_8$  : 18 pF  
 $C_9$  : 20 pF

Unit: mm

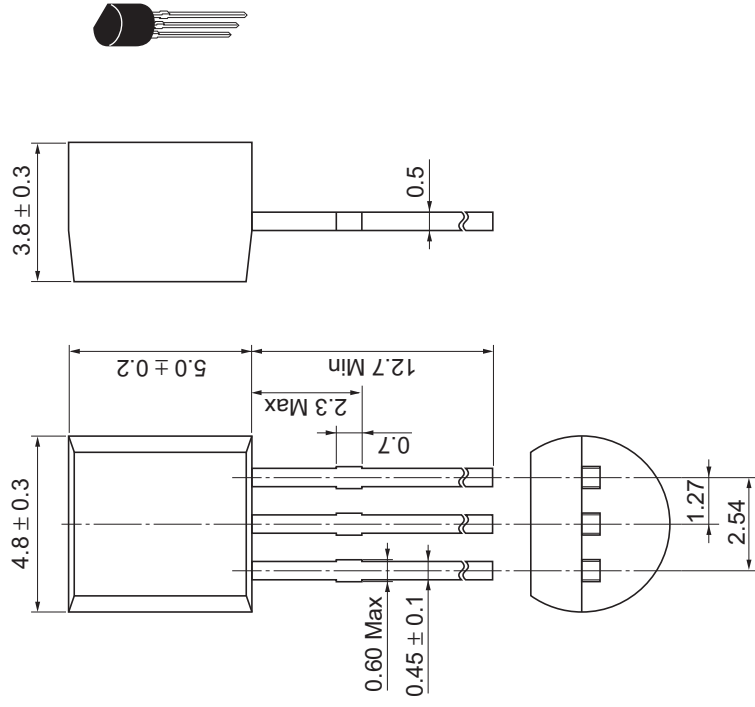

Hitachi Code	TO-92 (2)
JEDEC	Conforms
EIAJ	Conforms
Weight (reference value)	0.25 g

---

---

## Cautions

1. Hitachi neither warrants nor grants licenses of any rights of Hitachi's or any third party's patent, copyright, trademark, or other intellectual property rights for information contained in this document. Hitachi bears no responsibility for problems that may arise with third party's rights, including intellectual property rights, in connection with use of the information contained in this document.
2. Products and product specifications may be subject to change without notice. Confirm that you have received the latest product standards or specifications before final design, purchase or use.
3. Hitachi makes every attempt to ensure that its products are of high quality and reliability. However, contact Hitachi's sales office before using the product in an application that demands especially high quality and reliability or where its failure or malfunction may directly threaten human life or cause risk of bodily injury, such as aerospace, aeronautics, nuclear power, combustion control, transportation, traffic, safety equipment or medical equipment for life support.
4. Design your application so that the product is used within the ranges guaranteed by Hitachi particularly for maximum rating, operating supply voltage range, heat radiation characteristics, installation conditions and other characteristics. Hitachi bears no responsibility for failure or damage when used beyond the guaranteed ranges. Even within the guaranteed ranges, consider normally foreseeable failure rates or failure modes in semiconductor devices and employ systemic measures such as fail-safes, so that the equipment incorporating Hitachi product does not cause bodily injury, fire or other consequential damage due to operation of the Hitachi product.
5. This product is not designed to be radiation resistant.
6. No one is permitted to reproduce or duplicate, in any form, the whole or part of this document without written approval from Hitachi.
7. Contact Hitachi's sales office for any questions regarding this document or Hitachi semiconductor products.

---

---

# HITACHI

## Hitachi, Ltd.

Semiconductor & Integrated Circuits.  
Nippon Bldg., 2-6-2, Ohte-machi, Chiyoda-ku, Tokyo 100-0004, Japan  
Tel: Tokyo (03) 3270-2111 Fax: (03) 3270-5109

URL      NorthAmerica      : <http://semiconductor.hitachi.com/>  
             Europe                : <http://www.hitachi-eu.com/hel/ecg>  
             Asia (Singapore)        : <http://www.has.hitachi.com.sg/grp3/sicd/index.htm>  
             Asia (Taiwan)            : [http://www.hitachi.com.tw/E/Product/SICD\\_Frame.htm](http://www.hitachi.com.tw/E/Product/SICD_Frame.htm)  
             Asia (HongKong)        : <http://www.hitachi.com.hk/eng/bo/grp3/index.htm>  
             Japan                     : <http://www.hitachi.co.jp/Sicd/indx.htm>

### For further information write to:

Hitachi Semiconductor  
(America) Inc.  
179 East Tasman Drive,  
San Jose, CA 95134  
Tel: <1> (408) 433-1990  
Fax: <1>(408) 433-0223

Hitachi Europe GmbH  
Electronic components Group  
Dornacher StraÙe 3  
D-85622 Feldkirchen, Munich  
Germany  
Tel: <49> (89) 9 9180-0  
Fax: <49> (89) 9 29 30 00  
  
Hitachi Europe Ltd.  
Electronic Components Group.  
Whitebrook Park  
Lower Cookham Road  
Maidenhead  
Berkshire SL6 8YA, United Kingdom  
Tel: <44> (1628) 585000  
Fax: <44> (1628) 778322

Hitachi Asia Pte. Ltd.  
16 Collyer Quay #20-00  
Hitachi Tower  
Singapore 049318  
Tel: 535-2100  
Fax: 535-1533

Hitachi Asia Ltd.  
Taipei Branch Office  
3F, Hung Kuo Building, No.167,  
Tun-Hwa North Road, Taipei (105)  
Tel: <886> (2) 2718-3666  
Fax: <886> (2) 2718-8180

Hitachi Asia (Hong Kong) Ltd.  
Group III (Electronic Components)  
7/F., North Tower, World Finance Centre,  
Harbour City, Canton Road, Tsim Sha Tsui,  
Kowloon, Hong Kong  
Tel: <852> (2) 735 9218  
Fax: <852> (2) 730 0281  
Telex: 40815 HITEC HX

Copyright ' Hitachi, Ltd., 1999. All rights reserved. Printed in Japan.

**HITACHI**

# HandsOn Technology

<http://www.handsontec.com>

creativity for tomorrow's better living...

*HandsOn Tech provides a multimedia and interactive platform for everyone interested in electronics. From beginner to diehard, from student to lecturer... Information, education, inspiration and entertainment. Analog and digital; practical and theoretical; software and hardware...*



HandsOn Technology support Open Source Hardware(OSHW) Development Platform.

**Learn : Design : Share**

[www.handsontec.com](http://www.handsontec.com)





[www.handsontec.com](http://www.handsontec.com)

## Welcome to Handsontec Store



LCD+Keyboard Shield

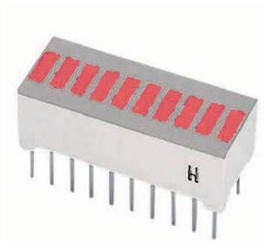

10-Segments LED Bar Display

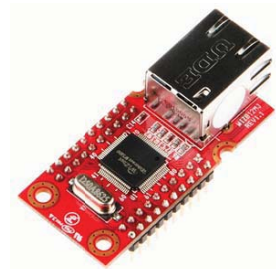

Ethernet Module



Arduino Uno



MicroSD Breakout Board

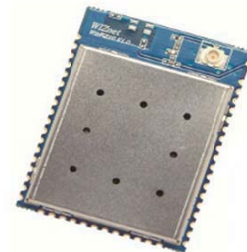

WiFi Module



20x4 LCD Display Module



Stepper Motor Driver

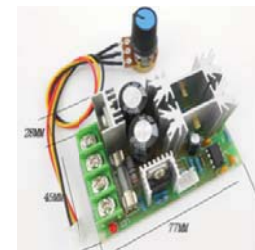

PWM Motor Speed Controller



[www.handsontec.com](http://www.handsontec.com)

Breakout Board & Modules



[www.handsontec.com](http://www.handsontec.com)

Integrated Circuits



[www.handsontec.com](http://www.handsontec.com)

Discrete Parts



[www.handsontec.com](http://www.handsontec.com)

Assembled Kits



[www.handsontec.com](http://www.handsontec.com)

Connectors